



T10L60B



Excellent Schottky Barrier Rectifiers



DO-214AA(SMB)

Primary Characteristics		
I_F	10	A
V_{RRM}	60	V
I_{FSM}	200	A
V_F	0.52	V
$T_J \text{ max}$	150	°C

Features
<ul style="list-style-type: none"> • High current capability • High surge current capability • Low reverse current • Component in accordance to RoHS 2002/95/EC

Mechanical Data
• Case: DO-214AA(SMB)
• Case Material: Molded Plastic. UL Flammability Classification Rating 94V-0
• Terminals: Lead Free Plating (Tin Finish). Solderable per MIL-STD-202, Method 208
• Polarity: Cathode Band
• Weight: 0.092 grams (approximate)

Ordering Information			
Part No.	Remark	Package	Packing
T10L60B	General	SMB	3000 / Tape & Reel
T10L60B-H	Halogen Free		
T10L60B-Q	AEC-Q101 qualified		

Maximum Ratings (TA=25°C unless otherwise noted)			
PARAMETER	SYMBOL	T10L60B	UNIT
Maximum repetitive peak reverse voltage	V_{RRM}	60	V
Maximum RMS voltage	V_{RMS}	42	V
Maximum DC blocking voltage	V_{DC}	60	V
Maximum average forward rectified current	I_F	10	A
Peak forward surge current, 8.3ms single half sine-wave superimposed on rated load	I_{FSM}	200	A
Maximum Instantaneous Forward Voltage $I_F=2A @ 25^\circ C$ $I_F=10A @ 25^\circ C$	V_F	0.34 Typ. 0.52 Max.	V
Maximum DC Reverse Current @ TA=25°C at Rated DC Blocking Voltage @ TA=100°C	I_R	0.5 10	mA
Typical Junction Capacitance(NOTE1)	C_j	730	pF
Typical Thermal Resistance	$R_{\theta JC}$	10	°C/W
Operating Temperature Range	T_J	-55 to +150	°C
Storage Temperature Range	T_{STG}	-55 to +150	°C
Marking Code		T10L60B、10L60B	

NOTES:

1. Measured at 1.0MHZ and applied reverse voltage of 4.0V DC

Rating and Characteristics Curves

FIG. 1-Typical Forward Current Derating Curve

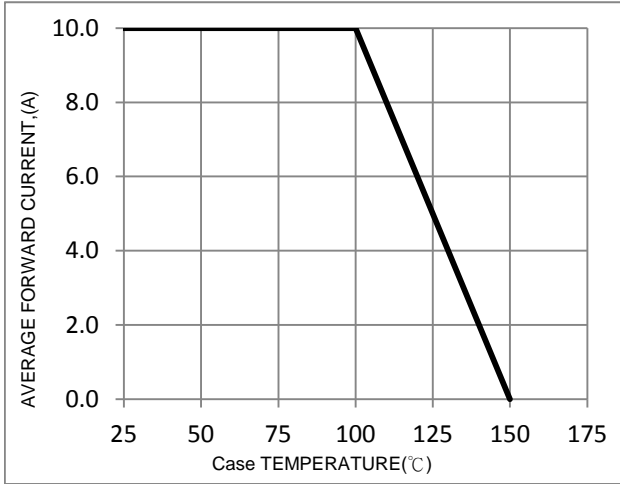

FIG. 2-Typical Forward Characteristics

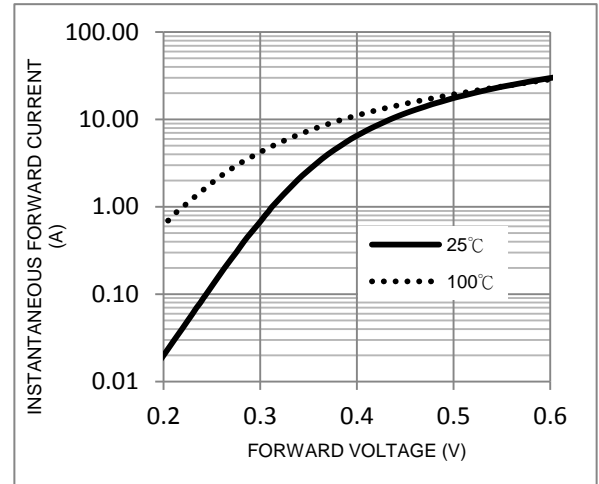

FIG. 3-Maximum Non-Repetitive Forward Surge Current

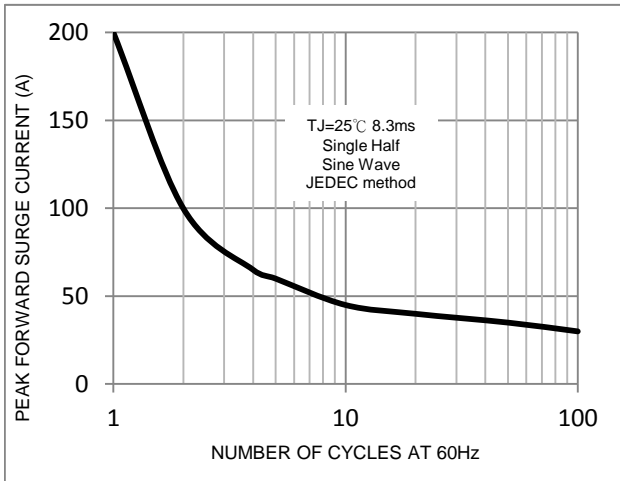

FIG. 4-Typical Reverse Characteristics

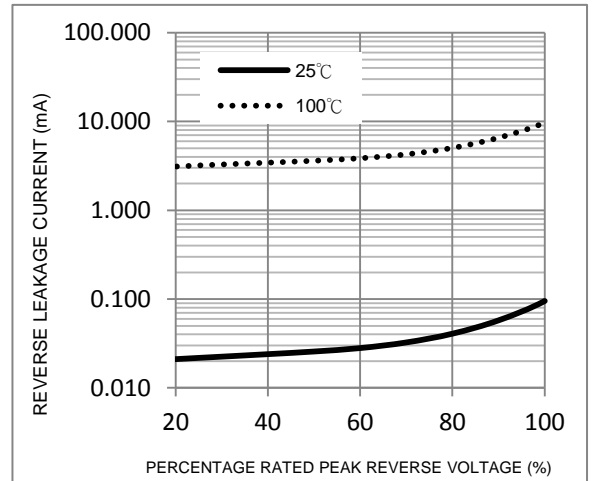
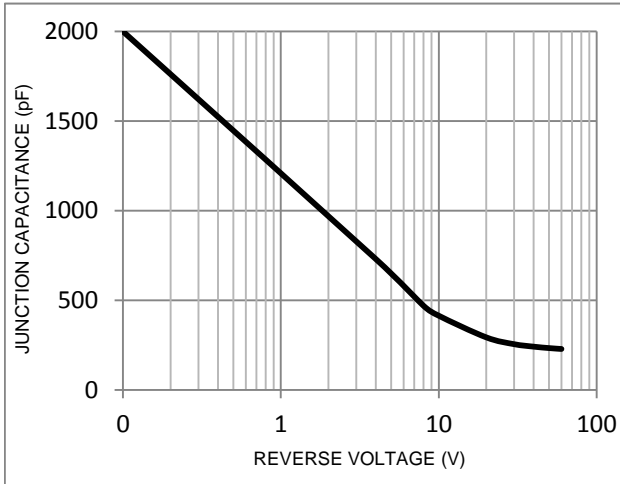
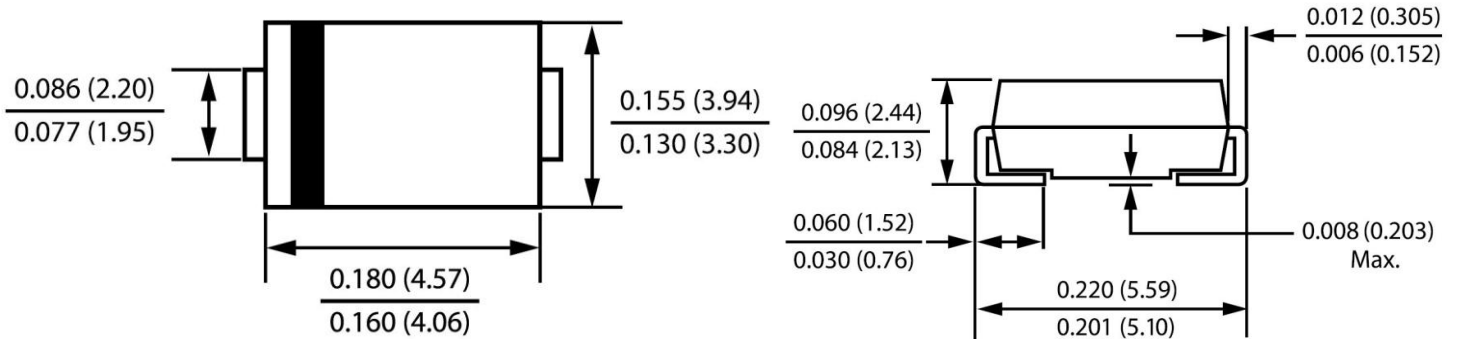

FIG. 5-Typical Junction Capacitance



Excellent Schottky Barrier Rectifiers

Package Outline Dimensions



DO-214AA(SMB)

Dimensions in inches and (millimeters)

Marking Information

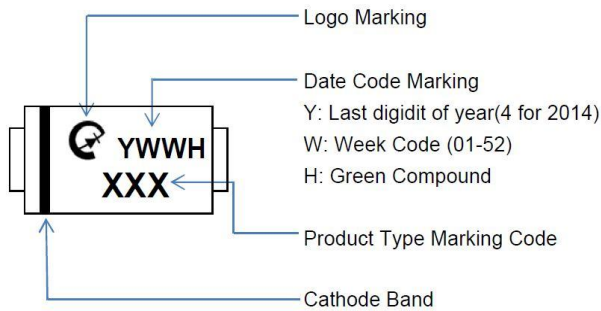

Suggested Pad Layout

Dimension	Outline	SMB (DO-214AA)
A		6.80
B		1.80
C		2.30
D		2.50
E		4.30

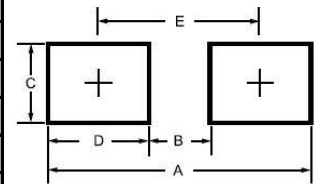

Tape & Reel Specification

ITEM	SYMBOL	SMB(mm) DO-214AA
Carrier width	A	4.0(max)
Carrier length	B	5.9(max)
Carrier depth	C	3.0(max)
Sprocket hole	d	1.50±0.1
Reel outside diameter	D	330±2.0
Feed hole diameter	D0	13.5±1
Reel inner diameter	D1	50 (min.)
Sprocket hole position	E	1.75±0.1
Punch hole position	F	5.5±0.05
Sprocket hole pitch	P	8.0±0.1
Sprocket hole pitch	Po	4.0±0.1
Embossment center	P1	2.0±0.05
Overall tape thickness	T	0.6 (max)
Tape width	W	12.0±0.3
Reel width	W2	18.4 (max)
Reel width	W1	14.4 (max)

