

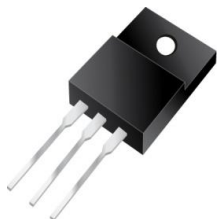

# P20E60FCT



## Excellent Schottky Barrier Rectifiers



ITO-220AB

Features
<ul style="list-style-type: none"> <li>• Low Forward Voltage Drop</li> <li>• Excellent High Temperature Stability</li> <li>• Excellent Barrier Rectifier Technology</li> <li>• Soft, Fast Switching Capability</li> </ul>

Device P/N	
Part Number	Remark
P20E60FCT	General
P20E60FCT-H	Halogen Free

Primary Characteristics		
$I_F$	20	A
$V_{RRM}$	60	V
$I_{FSM}$	150	A
$V_F$	0.6	V
$T_J \text{ max}$	150	°C

Ordering Information		
Part No.	Package	Packing
P20E60FCT	ITO-220AB	50 & 2000 / Tube & Box

Mechanical Data
<ul style="list-style-type: none"> <li>• Case: ITO-220AB</li> <li>• Case Material: Molded Plastic, UL Flammability Classification Rating 94V-0</li> <li>• Terminals: Matte Tin Finish annealed over Copper leadframe. Solderable per MIL-STD-202, Method 208</li> <li>• Weight: 1.645 grams (approximate)</li> </ul>

Maximum Ratings (TA=25°C unless otherwise noted)			
PARAMETER	SYMBOL	P20E60FCT	UNIT
Maximum repetitive peak reverse voltage	$V_{RRM}$	60	V
Maximum RMS voltage	$V_{RMS}$	42	V
Maximum DC blocking voltage	$V_{DC}$	60	V
Maximum average forward rectified current (Total) (Per Leg)	$I_F$	20 10	A
Peak forward surge current, 8.3ms single half sine-wave superimposed on rated load	$I_{FSM}$	150	A
Maximum Instantaneous Forward Voltage $I_F=3A @ 25^\circ C$ $I_F=10A @ 25^\circ C$	$V_F$	0.36 Typ. 0.60 Max.	V
Maximum DC Reverse Current @ TA=25°C at Rated DC Blocking Voltage @ TA=125°C	$I_R$	0.3 25	mA
Typical Junction Capacitance(NOTE1)	$C_j$	410	pF
Typical Thermal Resistance	$R_{\theta JC}$	3	°C/W
Operating Temperature Range	$T_J$	-55 to +150	°C
Storage Temperature Range	$T_{STG}$	-55 to +175	°C
Marking Code		P20E60FCT · 20E60FCT	

NOTES:  
1. Measured at 1.0MHZ and applied reverse voltage of 4.0V DC



### Rating and Characteristics Curves

FIG. 1-Typical Forward Current Derating Curve

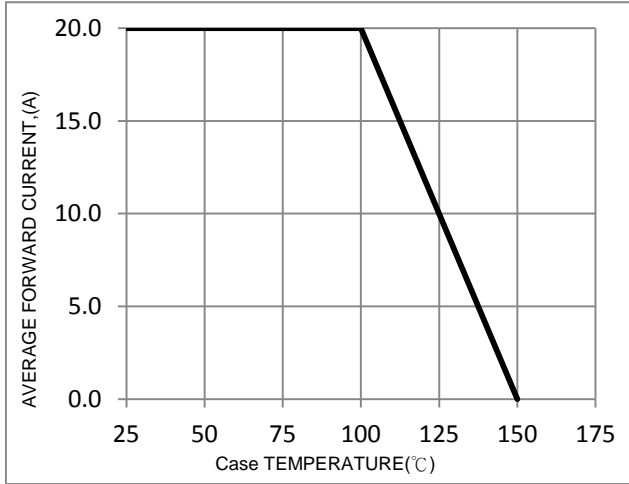

FIG. 2-Typical Forward Characteristics

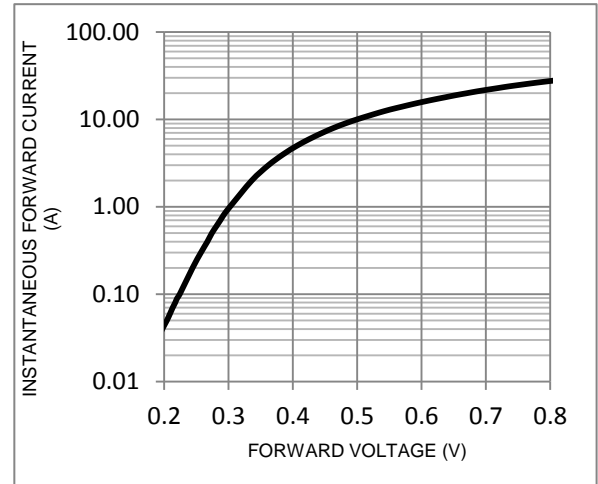

FIG. 3-Maximum Non-Repetitive Forward Surge Current

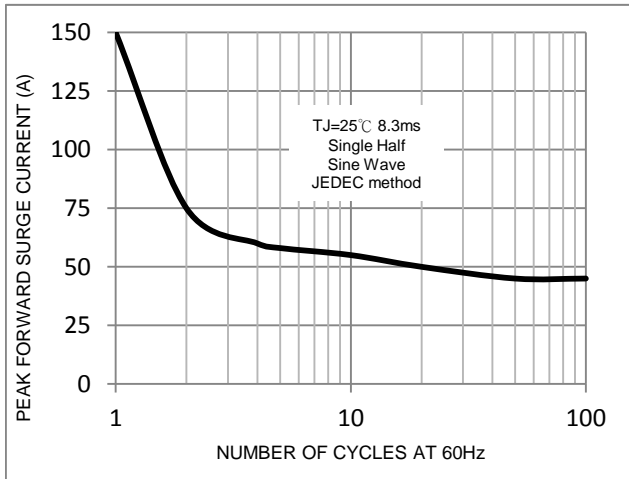

FIG. 4-Typical Reverse Characteristics

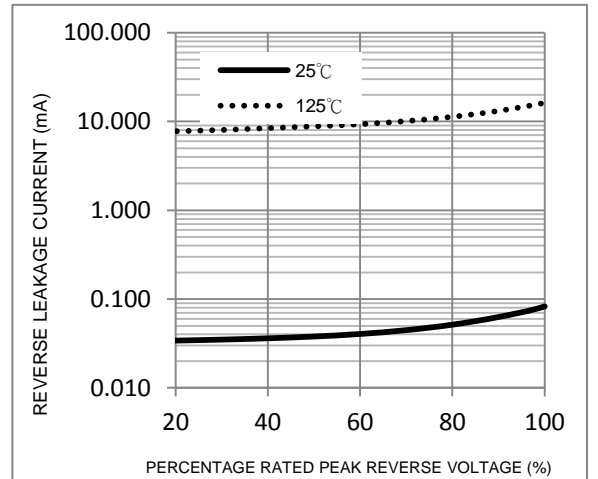
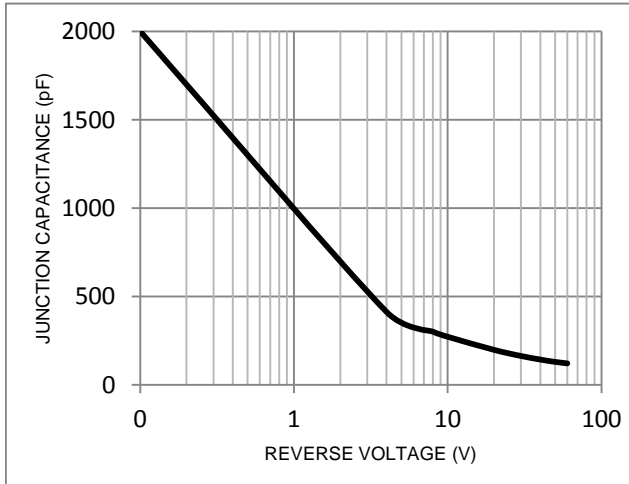
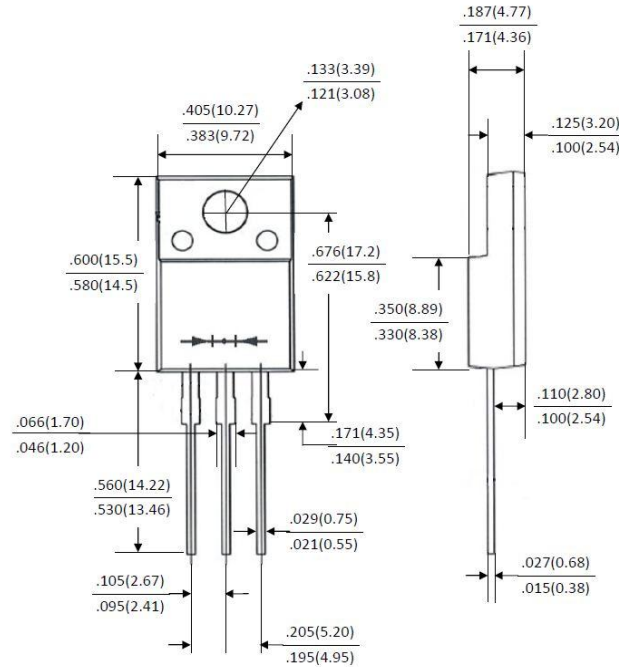

FIG. 5-Typical Junction Capacitance



### Package Outline Dimensions



### ITO-220AB

Dimensions in inches and (millimeters)

### Marking Information

