



P15E50T



Excellent Schottky Barrier Rectifiers



TO-277

Features
<ul style="list-style-type: none"> • Schottky barrier diodes • Low forward voltage drop • Low leakage current • Moisture sensitivity: level 1, per J-STD-020 • Solder dip 260 °C, 10 s • Low profile • Heatsink design

Ordering Information		
Part No.	Package	Packing
P15E50T	TO-277	5000 / Reel

Device P/N	
Part Number	Remark
P15E50T	General
P15E50T-H	Halogen Free

Primary Characteristics		
I_F	15	A
V_{RRM}	50	V
I_{FSM}	150	A
V_F	0.5	V
$T_J \text{ max}$	150	°C

Mechanical Data
<ul style="list-style-type: none"> • Case: TO-277 • Case Material: Molded Plastic. UL Flammability Classification Rating 94V-0 • Terminals: Lead Free Plating (Tin Finish). Solderable per MIL-STD-202, Method 208 • Polarity: Cathode Band • Weight: 0.096 grams (approximate)

Maximum Ratings (TA=25°C unless otherwise noted)			
PARAMETER	SYMBOL	P15E50T	UNIT
Maximum repetitive peak reverse voltage	V_{RRM}	50	V
Maximum RMS voltage	V_{RMS}	35	V
Maximum DC blocking voltage	V_{DC}	50	V
Maximum average forward rectified current	I_F	15	A
Peak forward surge current, 8.3ms single half sine-wave superimposed on rated load	I_{FSM}	150	A
Maximum Instantaneous Forward Voltage IF=3A @ 25°C IF=15A @ 25°C	V_F	0.33 Typ. 0.50 Max.	V
Maximum DC Reverse Current @ TA=25°C at Rated DC Blocking Voltage @ TA=100°C	I_R	0.5 100	mA
Typical Junction Capacitance(NOTE1)	C_j	930	pF
Typical Thermal Resistance	$R_{\theta JC}$	10	°C/W
Operating Temperature Range	T_J	-55 to +150	°C
Storage Temperature Range	T_{STG}	-55 to +150	°C
Marking Code		15E50T、P15E50T	

NOTES:

1. Measured at 1.0MHZ and applied reverse voltage of 4.0V DC



Rating and Characteristics Curves

FIG. 1-Typical Forward Current Derating Curve

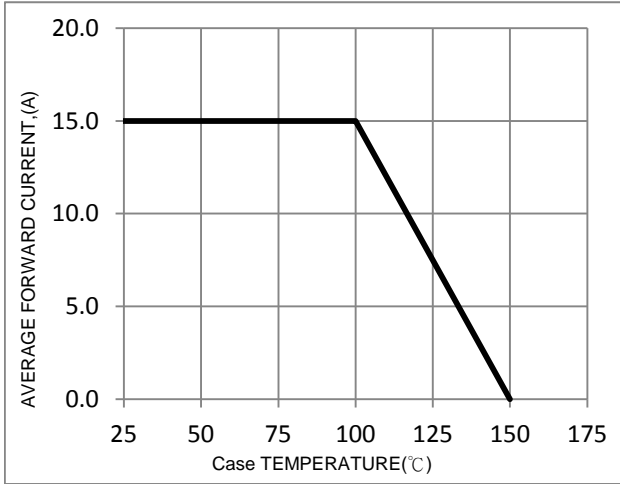

FIG. 2-Typical Forward Characteristics

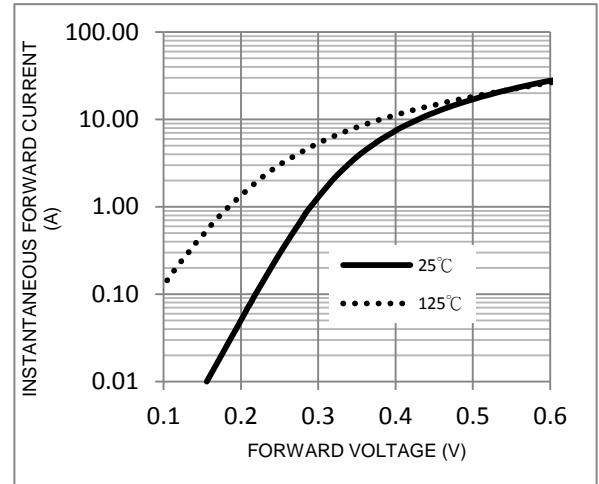

FIG. 3-Maximum Non-Repetitive Forward Surge Current

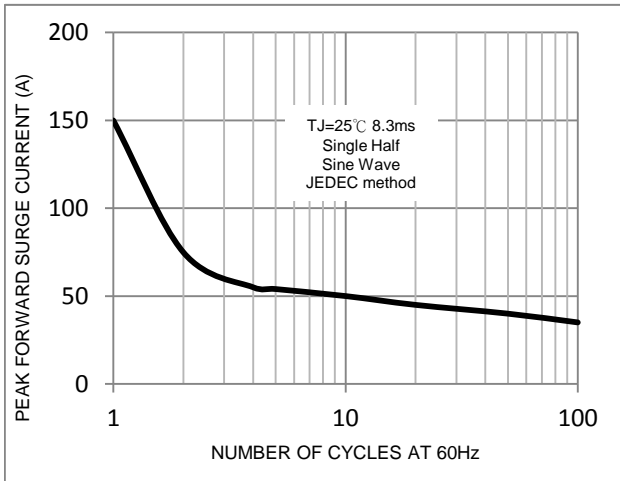

FIG. 4-Typical Reverse Characteristics

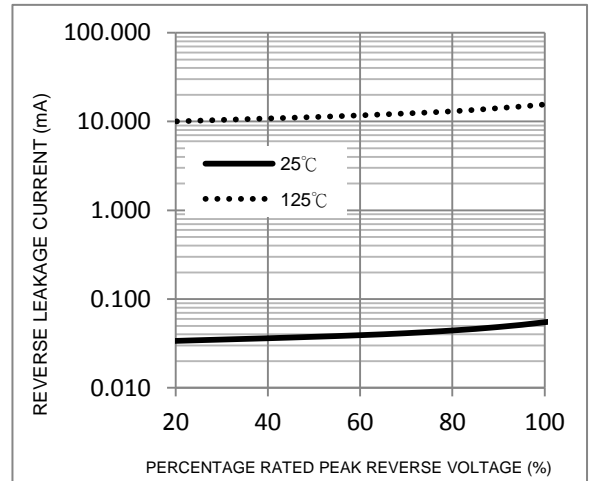
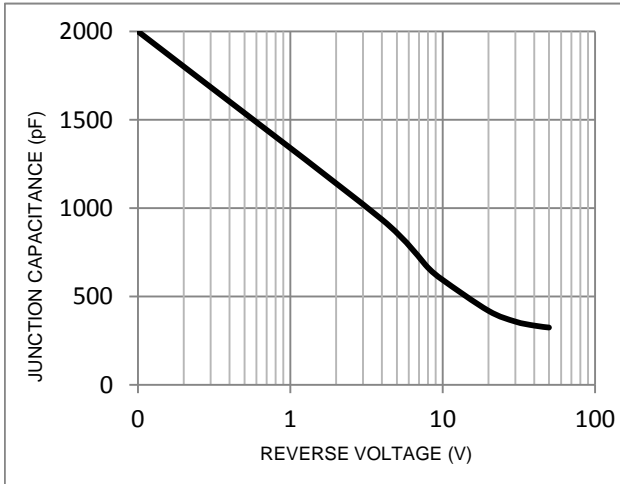
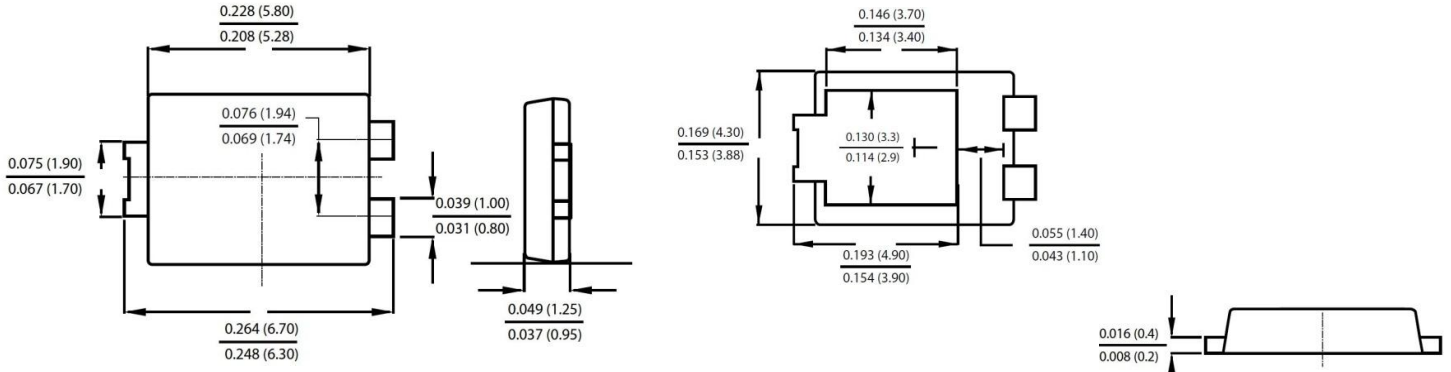

FIG. 5-Typical Junction Capacitance



Package Outline Dimensions



TO-277

Dimensions in inches and (millimeters)

Marking Information

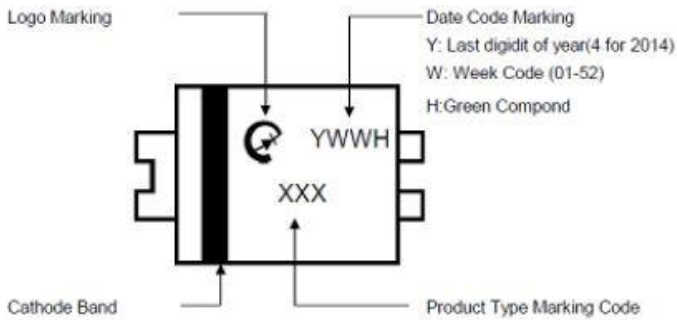

Suggested Pad Layout

Dimension	Outline	TO-277
A		1.94
B		1.00
C		3.20
D		4.90
E		1.00
F		1.40

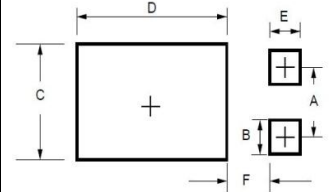

Tape & Reel Specification

ITEM	SYMBOL	TO-277 (mm)
Carrier width	A	4.38(max)
Carrier length	B	6.9(MAX)
Carrier depth	C	1.4±0.1
Sprocket hole	d	1.50±0.1
Reel outside diameter	D	330±2.0
Feed hole diameter	D0	13.0±0.2
Reel inner diameter	D1	100 (min.)
Sprocket hole position	E	1.75±0.1
Punch hole position	F	7.5±0.05
Sprocket hole pitch	P	8.0±0.1
Sprocket hole pitch	Po	4.0±0.1
Embossment center	P1	2.0±0.10
Overall tape thickness	T	0.6 (max)
Tape width	W	16.0±0.3
Reel width	W2	20(max)
Reel width	W1	16(max)

